

Research Journal of Pharmaceutical, Biological and Chemical Sciences

Mathematical Modeling for Simulating the Thin Layer Drying of Hayani Date Using an Infrared Dryer.

Ahmed El-Raie Emam Suliman¹, Mohamed Mustafa Elkoly², Yossry Bayoumy Abd Elhay³, and Shymaa Saad Sayed Ibrahim^{4*}.

¹Professor of Agricultural Engineering, Faculty of Agriculture, Cairo University, Egypt.

²Prof. of Food Process Engineering and Deputy Director of Agricultural, Agricultural Engineering Researcher Institute, Agricultural Researcher Center, Dokkie, Giza. Egypt.

³Assistant Prof., Agricultural Engineering Department, Faculty of Agriculture, Cairo University, Egypt.

⁴Agric. Engineer, Agricultural Engineering Researcher Institute, Agricultural Researcher Center, Dokkie, Giza. Egypt.

ABSTRACT

A study was carried out to test and evaluate the use of infra-red radiation as heat energy source for drying whole date palm fruits. Where in this study an infrared dryer was developed and tested at the laboratory of the Department of Agricultural Engineering, Faculty of Agriculture, Cairo University. The initial moisture content of hayani date was 58.5 % (w.b.). High moisture hayani was dried under four different levels of infra-red radiation intensity (0.649, 0.973, 1.093, and 1.161 kW/m²), three different levels of air temperature (40, 50 and 60°C) and three different levels of air velocity (0.5, 1 and 1.5 m/sec). The drying behavior was simulated using two different thin layer models (Lewis and Henderson and Pabis). The studied models were compared for simulating and predicting the change in dates moisture during drying process. The obtained results showed that, both of the examined models could describe the drying behavior of dates satisfactorily. However, the Lewis's model considered more proper for describing the drying behavior more than the Henderson and Pabis's model. Where, Lewis's model showed the higher values of coefficient of determination ($R^2=0.99191$) and lower values of standard error (SE=1.59106), chi-square ($\chi^2=0.00437$) and root mean square error (RMSE =0.07064).

Keywords: Infra-red, Drying, Date palm, Mathematical modeling, Moisture content.

**Corresponding author*

INTRODUCTION

Date Palm (*Phoenix dactylifera* L.) has been one of the most important fruit crops in the arid regions of the Arabian, Middle East and North Africa (MENA) [1]. It is one of the oldest trees from which man has derived benefit, and it has been cultivated since ancient times [2].

Production of palm in the world approached about 7.7 million tons. A some of about 5.9 million tons produced in the Arab world which equals to about 81.15% of the world production. Date production of Egypt alone represents about 18.89 % of the total World production[3].Date palm trees are grown all-over Egyptian lands from Alexandria north up to Aswan-South and from Red Sea East up to the New Valley and Oases in the West [4].

Damietta Governorate is famous for its production of dates especially "Hayani" dates, are producing large amounts of it in short time. "Hayani" dates gives high output and exposed to rapid deterioration during the marketing of dates, where doesn't stay more than 3-4 days at room temperature and become unfit for consumption, this leads to significant loss of production and not to take advantage of it so was the idea to drying the dates and stored to use throughout the year [5].

Drying is one of the most prevailing methods of food preservation, where the moisture is removed preventing the growth of micro-organisms that causes food damage. This method helps in reducing the weight and volume of the product which reduces the transportation and storage load and also helps in storing the food in ambient temperature [6]. Drying of fresh dates is necessary because it contains a high moisture (about 60%) which limits the shelf life [7].

New and innovative techniques that increase the drying rate and enhance product quality have achieved considerable attention in the recent past. Drying by infrared radiation is one among them, gaining popularity because of its inherent advantages over conventional heating[8].

Infrared (IR) radiation drying has been investigated as a potential method for obtaining high quality dried foodstuffs, including fruits, vegetables, rice and other grains [9]. IR radiation drying is fundamentally different from convection drying where IR energy is transferred from the heating element to the product surface without heating the surrounding air [10]. Application of infrared radiation to food processing has gained momentum due to its inherent advantages over hot-air heating. Infrared processing has been tried in baking, roasting, thermal treatments (blanching, pasteurization, sterilization, etc.) and drying of foodstuffs[11]. In general, FIR radiation is advantageous for food processing because most food components absorb radiative energy in the far infrared (FIR) region [11].

Mathematical modeling of thin layer drying is important for optimum management of operating parameters and prediction of performance of the drying system. A thermal model for the prediction of crop temperature and moisture evaporation during thin layer open sun drying was developed [12].

The general objective of the present work was to examine two different drying models (Lewis and Henderson and Pabis) for simulating the drying behavior of whole fruits hayani dates using infrared dryer.

MATERIALS AND METHODS

Materials

Tested crop

Fresh ripe hand harvested samples of date palm "Hayani" were used for the experimental work. It was obtained from a local date producing farm in Demiata governorate in September (2016). The initial moisture content of the freshly harvested date was 58.5 % (w.b.).

Structure of the laboratory scale infrared dryer

Figure 1, shows the general view of the schematic diagram of the proto-type dryer used for the experimental work.

The drying bed shown in Figure 1 constructed of an iron frames of 35×30×56cm and the base of tray is wire net and made of stainless steel. The size of sample holding tray was 50x28x2cm. It was placed facing the infrared lamps in vertical consequence with distances of 17cm between the trays and the heating sources. For heating and temperature control of the dryer, two (1kW) ceramic Infra-red heaters are fixed over two iron blades and assembled into the sealing of drying chamber facing the drying trays. To control the radiation intensity of the infra-red heaters a digital dimmer was used. And for air heating, an electric heater (1 kW) was used. Heater was connected to a thermocouple type (T) to control and measure air temperature, where a thermocouple was placed on the core of date palm to measure the fruit temperature during the drying process. For air supply, an axial flow fans model 220wzl-10W-1500 rpm was used for suction of heated air in a parallel direction over the surface of drying tray. A fan assembled in one side of the drying chamber facing the heater. The centrifugal fan was connected to force the air over the drying bed at different velocities. The fan was used a speed digital control switch.

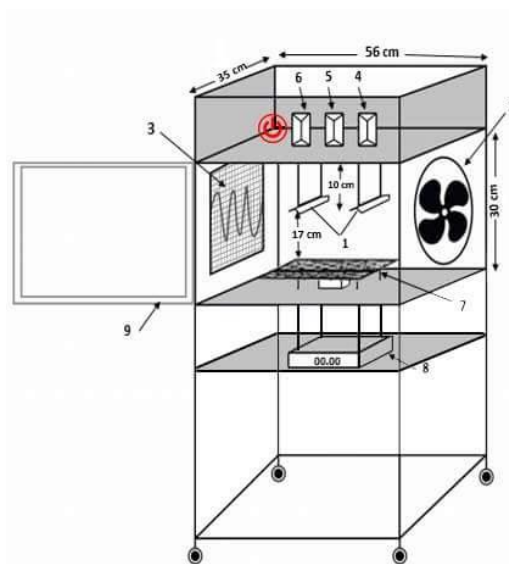

Figure 1: Schematic diagram of experimental infra-red dryer.

- | | | |
|----------------------|-------------------------|--------------------|
| 1- Infra-red heaters | 4- Dimmers of infra-red | 7- Sample's tray |
| 2- Axial flow fan | 5- Fan's switch | 8- Digital balance |
| 3- Electric heater | 6- Thermostat | 9- Door glass |

Experimental Treatments

The experimental parameters included the following:

1. Four different levels of infra-red radiation intensity (0.649, 0.973, 1.093, and 1.161 kW/m²).
2. Three different levels of inlet air temperature (40, 50 and 60°C).
3. Three different levels of air velocity (0.5, 1 and 1.5 m/sec).

Date samples were stored in plastic bags and kept in a freezer at (-18°C) until used. Before any experimental run, the date sample taken out of the freezer and kept inside the laboratory to attain room temperature.

The infrared radiation, air temperature and air velocity were adjusted to be approximately constant during every experiment at the selective levels of treatments. The dates palm were distributed uniformly as a single layer of 100 g for each sample on a perforated tray which is then placed directly inside the drying chamber at a the distance of 17 cm from two ceramic Infra-red heaters. The output from the weighting balance, indicated as weight changes of the samples which were recorded every 15 min along the first two hours and every 30 min along the next two hours, and every 60 min up to the end of the run .After each experimental run the dehydrated dates were cooled for 15 min and then stored in low-density polyethylene bags.

At the same time (100 g, in duplicate) were taken from the fresh dates palm and to determine the initial moisture content on a wet basis by the method described by [13]using the drying oven method at 70°Cuntil reaching a constant weight.

Measurements and Instrumentation

Moisture content determination

Initial moisture contents of date palm fruits are determined by the method described in [14] using a German electric oven at 70°C until reaching a constant weight (48 h was sufficient).

Radiation intensity measurement:

A radiation sensor with data recorder (model H-201) was used for measurement of radiation intensity.

Air velocity measurement

Hygro-thermo-anemometer temperature / relative humidity / air velocity meter (model 407412) made in German was used for measuring the air velocity with an accuracy of 0.01 m/sec.

Temperature measurement

Hygro-thermo- anemometer model (407412) was connected to an Iron-Constantine thermocouple type (T) was used to measure air and sample temperatures with an accuracy of $\pm 0.8^{\circ}\text{C}$.

The examined drying models for simulating the drying data

The obtained data of the laboratory experiments was employed to examine the applicability of the two studied thin layer drying models (Lewis's and Henderson and Pabis's equations) on describing and simulating the drying data.

The examined drying models included

Lewis's model

$$MR = \exp(-k_L t) \quad (1)$$

$$MR = \frac{M_t - M_f}{M_o - M_f}$$

Where:

- MR** : The moisture ratio.
- M_t** : Moisture content at a specific time, ($\text{g}_{\text{water}} / \text{g}_{\text{solid}}$).
- M_o** : The initial moisture content, ($\text{g}_{\text{water}} / \text{g}_{\text{solid}}$).
- M_f** : The Final moisture content, ($\text{g}_{\text{water}} / \text{g}_{\text{solid}}$).
- K_L** : Drying constant, (min^{-1}).
- t** : Drying time, (min.).

Lewis's model has been applied to fit the drying data of the dates. After converting its form to the logarithmic form relating the moisture ratio (MR) of the sample with the elapsed drying time (t) as follows:

$$\ln MR = (-kt)$$

The analysis was conducted based on using the final moisture content (M_f) for calculating the moisture ratio (MR).

Henderson and Pabis's model

$$MR = A \cdot \exp(-k_n t) \tag{2}$$

Where:

- A : Drying constant, (dimensionless).
- k_n : Drying constant, (min^{-1}).

Henderson and Pabis's model has been applied to fit the drying data of the dates. After converting its form to the exponentially form and calculating the constants (k and A) from relating the moisture ratio (MR) of the sample with the drying time (T).

RESULTS AND DISCUSSION

Influence of drying parameters on the change in date palm moisture ratio:

Figure 2 illustrates the change in date palm moisture ratio as related to drying time at different levels of drying air temperature, air velocity and radiation intensity. As shown in the figures, the reduction in moisture ratio of date palm varied with the experimental treatments and it was increased with the increase of radiation intensity, and the drying air temperature and decrease with increase of air velocity.

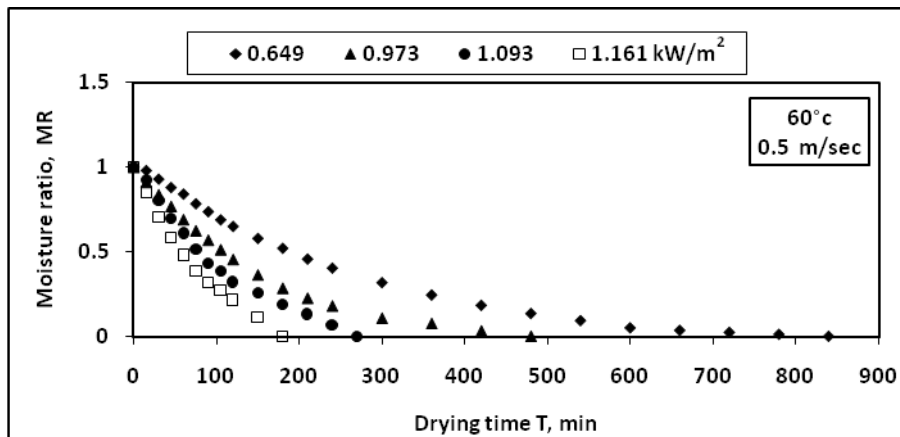

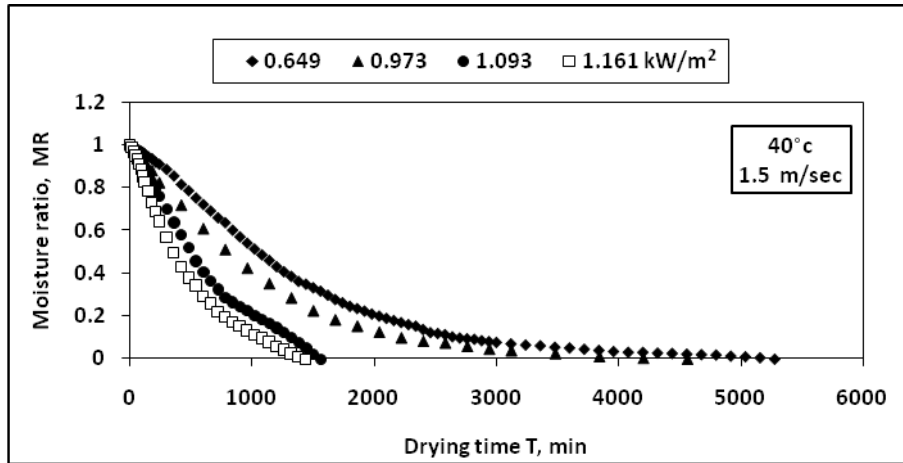
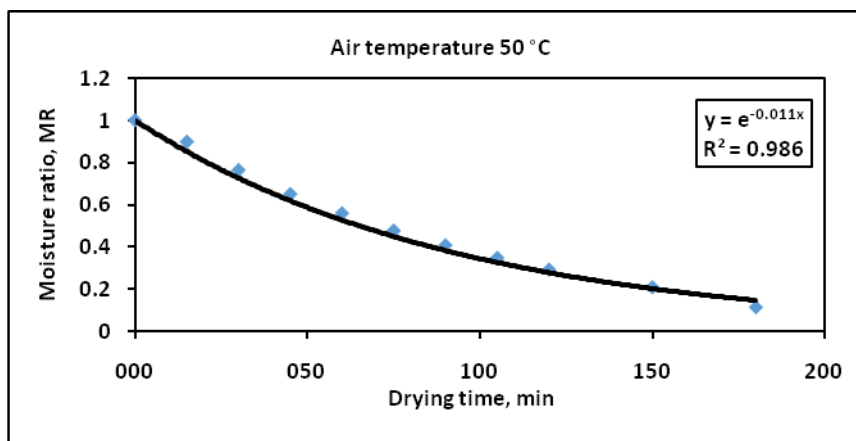
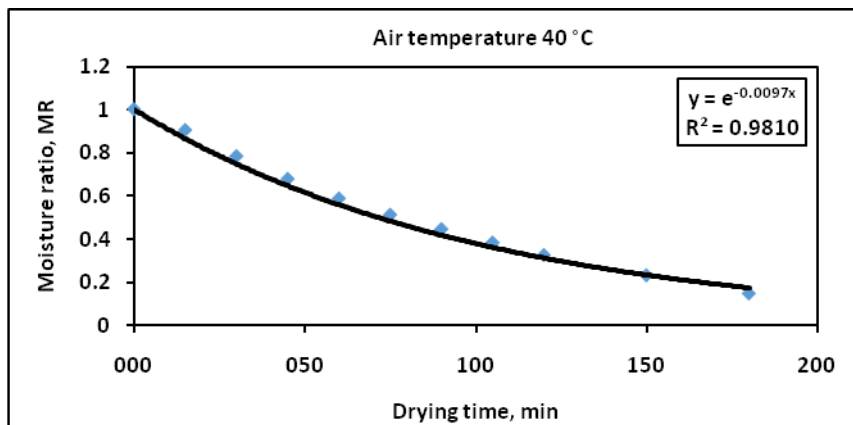

Figure 2: Dates palm moisture ratio as related to drying time at different levels of radiation intensity and maximum and minimum of air temperature and air velocity.

Analysis of thin layer drying of whole date palm fruits

Analysis of thin layer drying of whole fruits of date palm using Lewis’s model

The values of drying constant (k_L) for the Lewis’s model could be obtained from the exponential relationship between the moisture ratio (MR) of the tested sample versus drying time (t). Figures 3 presents this exponential relationship at the maximum radiation intensity of 1.161 kW/m² and drying air temperatures of 40, 50 and 60 °C at air velocity 0.5 m/sec. The computed values of drying constants k_L are listed in Table 1.



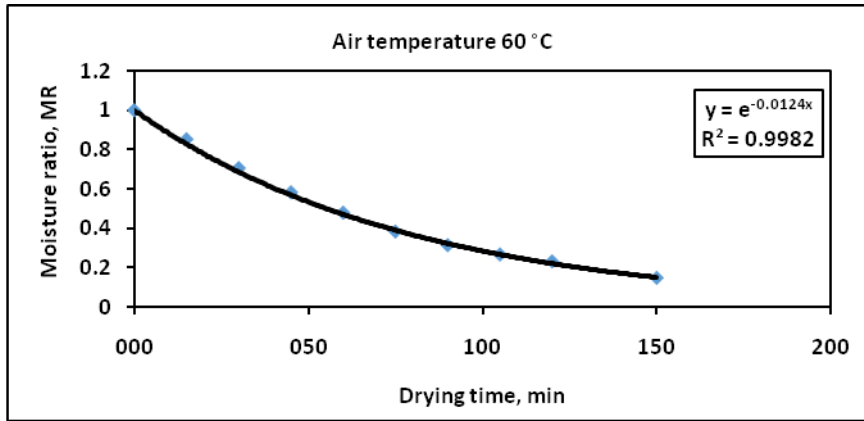

Figure 3: Drying constant (k_L) of Lewis’s model at the maximum radiation intensity of 1.161 kW/m², different drying air temperature and air velocity 0.5 m/sec.

Table 1: Drying constant (k_L) of Lewis’s model at different levels of drying radiation intensity, air temperature and air velocity

Infra-red radiation intensity, kW/m ²	Air temperature, °C	Air velocity, m/sec		
		0.5	1	1.5
0.649	40	0.0023	0.0013	0.00083
	50	0.0035	0.003	0.0026
	60	0.0048	0.0044	0.0039
0.973	40	0.0046	0.0023	0.0012
	50	0.0059	0.0043	0.003
	60	0.0074	0.0059	0.0045
1.093	40	0.0068	0.004	0.0018
	50	0.0085	0.006	0.0037
	60	0.0098	0.0077	0.0052
1.161	40	0.0097	0.0058	0.0024
	50	0.011	0.0079	0.0044
	60	0.0124	0.0096	0.0061

As shown in Table 1, the drying constant (k_L) increased with the increase of drying air temperature and the increase of radiation intensity. However, it was decreased with the increase of air velocity.

A multiple regression analysis was also made to proceed the studied parameters (I , T and V) with the drying constant (k_L). The nature of dependence could be expressed by the following equation:

$$k_L = 0.008315 I + 0.0001611 T - 0.003923 V - 0.006955 \quad (3)$$

(S.E. = 0.00117 ; R² = 0.84995 ; r = 0.92193)

Where:

- k_L = Drying constant of Lewis’s model, min⁻¹.
- I = IR radiation intensity, kW/m².
- T = Drying air temperature, °C.
- V = Air velocity, m/sec.

Analysis of thin layer drying of whole date palm fruits using Henderson and Pabis's model

The values of drying constant (k_h) and (A) for the Henderson and Pabis's model could be obtained from the exponential relationship between the moisture ratio (MR) of the tested sample versus drying time (t). The slope of the drying curve represents the drying constant (k_h) while the intercept represents the

constant (A) as shown in Figure 4. Figure 4 presents this exponential relationship at the maximum radiation intensity of 1.161 kW/m^2 and drying air temperatures of $40, 50$ and 60°C at air velocity 0.5 m/sec . The computed values of drying constants (k_h and A) are listed in Table 2.

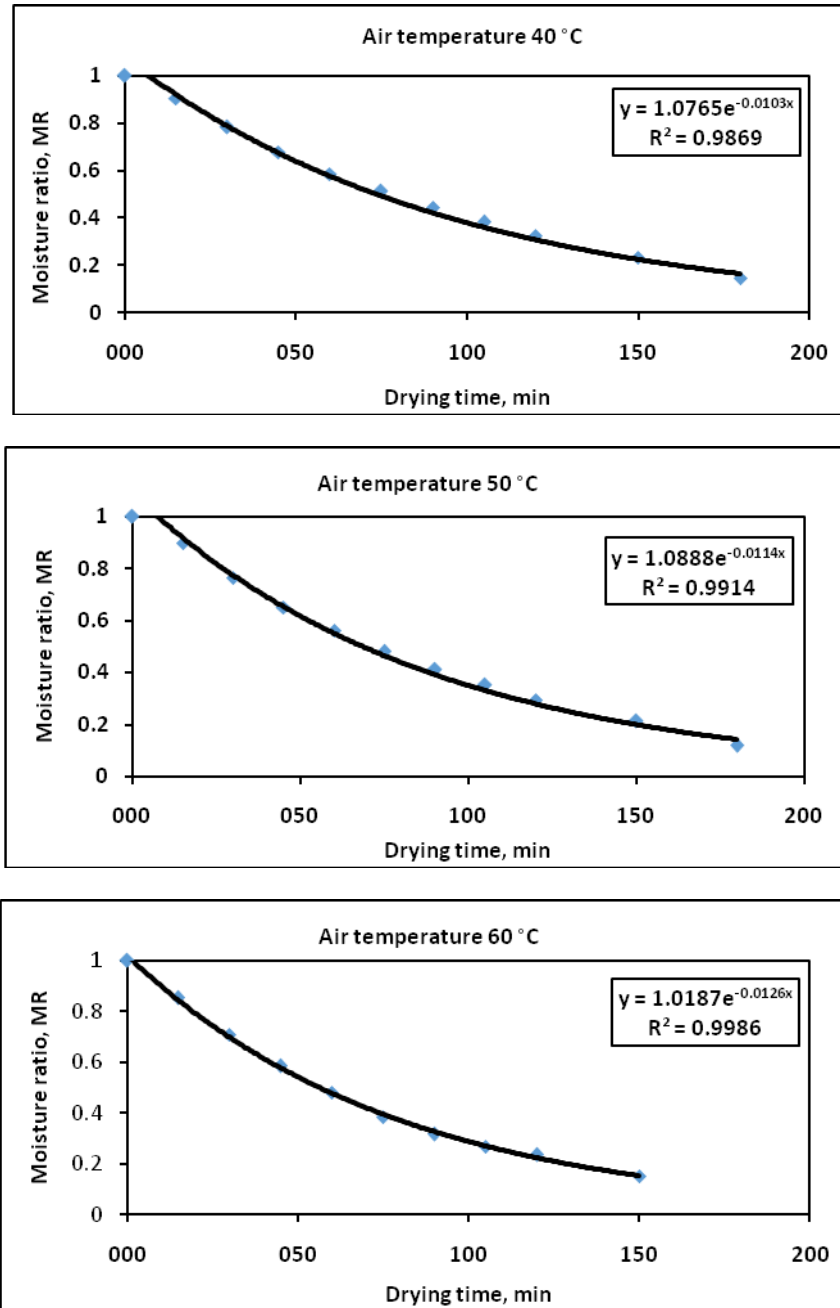

Figure 4: Drying constant (k_h, A) of Henderson and Pabis's model at the maximum radiation intensity of 1.161 kW/m^2 , different drying air temperature and air velocity 0.5 m/sec .

Table 2: Drying constant (k_h) of Henderson and Pabis's model at different levels of drying radiation intensity, air temperature and air velocity.

Infra-red radiation intensity, kW/m^2	Air temperature, $^\circ\text{C}$	Air velocity, m/sec		
		0.5	1	1.5
0.649	40	0.0024	0.0014	0.00088
	50	0.0038	0.0032	0.0027
	60	0.0053	0.0047	0.0043

0.973	40	0.0049	0.0025	0.0012
	50	0.0063	0.0046	0.0033
	60	0.0078	0.0065	0.0048
1.093	40	0.0074	0.0044	0.0019
	50	0.0093	0.0064	0.004
	60	0.0106	0.0082	0.0056
1.161	40	0.0103	0.0062	0.0026
	50	0.0114	0.0082	0.0049
	60	0.0126	0.01	0.0066

As shown in Table 2, the drying constant (k_h) increased with the increase of drying air temperature and the increase of radiation intensity. However, it was decreased with the increase of air velocity.

A multiple regression analysis was also made to proceed the studied parameters (I , T and V) with the drying constant (k_h). The nature of dependence could be expressed by the following equation:

$$k_h = 0.008718 I + 0.000171 T - 0.00411 V - 0.007275 \quad (4)$$

(S.E. = 0.001179 ; R2 = 0.861577 ; r = 0.92821)

Where:

- k_h = Drying constant of Lewis's model, min^{-1} .
- I = IR radiation intensity, kW/m^2 .
- T = Drying air temperature, $^{\circ}\text{C}$.
- V = Air velocity, m/sec .

Fitting curves examining the applicability of Lewis's and Henderson and Pabis's models in simulating the laboratory drying data

Lewis's model

The results indicated that, Lewis's model described the drying behavior of whole date palm fruits satisfactorily as indicated by the high values of coefficient of determination (R^2) and low values of standard error (SE). Figures 5 and 6 also show the measured and predicted values of moisture content at 45°C chart at the minimum and the maximum levels of drying air temperature, radiation intensity and air velocity.

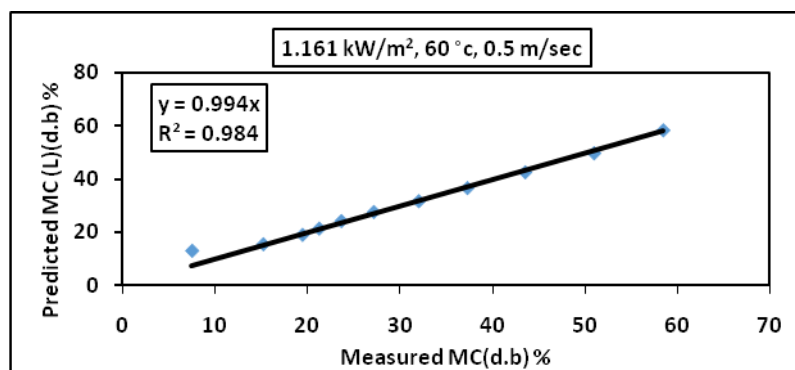

Figure 5: Measured and predicted values of whole date palm moisture content using Lewis's model at (I) 1.161 kW/m^2 , (T) 60°C and (V) 0.5 m/sec .

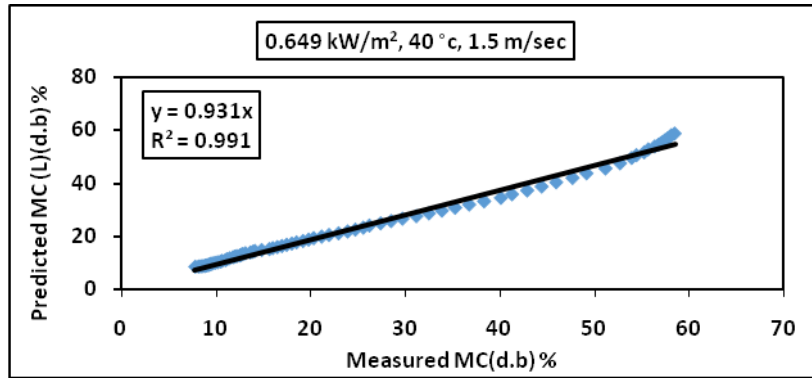

Figure 6: Measured and predicted values of whole date palm moisture content using Lewis's model at (I) 0.649 kW/m², (T) 40°C and (V) 1.5 m/sec.

Henderson and Pabis's model

The results indicated that, Henderson and Pabis's model described the drying behavior and predicted the change in moisture content of whole date palm fruits satisfactorily as indicated by the high values of coefficient of determination (R^2) and low values of standard error (SE). Figures 7 and 8 show the measured and the predicted values of date palm moisture content as 45°C chart at the minimum and the maximum levels of drying air temperature, radiation intensity and air velocity

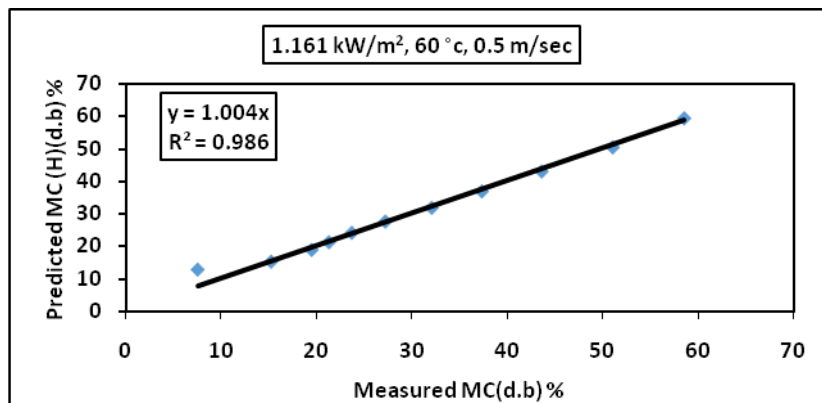

Figure 7: Measured and predicted values of whole date palm moisture content using Henderson and Pabis's model at (I) 1.161 kW/m², (T) 60°C and (V) 0.5 m/sec.

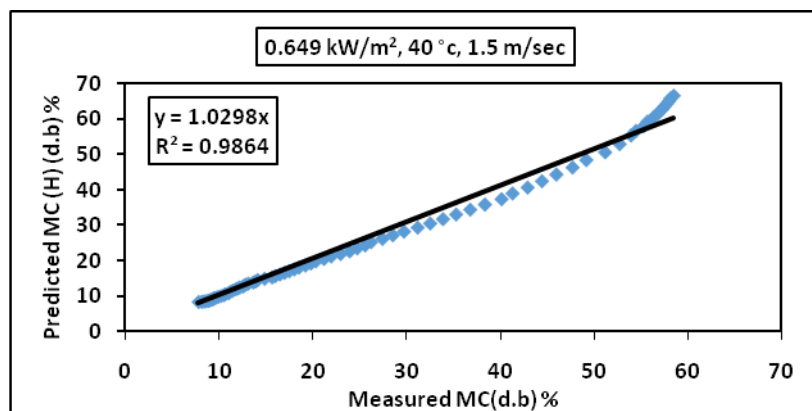

Figure 8: Measured and predicted values of whole date palm moisture content using Henderson and Pabis's model at (I) 0.649 kW/m², (T) 40°C and (V) 1.5 m/sec.

Comparative evaluation of the studied drying models for predicting the changes of moisture content of

whole date palm fruits

A comparison study for the two drying models (Lewis’s and Henderson and Pabis’s models) was conducted to assess the most appropriate drying model for simulating and describing the drying behavior of whole date palm under the studied range of experimental parameters. Table 3 presents the overall average of the obtained coefficient of determination (R^2) and the standard error (SE) for the observed and the calculated moisture ratio. The results showed that, both studied models could describe the drying behavior of whole date palm satisfactory as indicated from the higher coefficient of determinations (R^2) for the two models which ranged from (0.97889 to 0.99799). On the other hand, Lewis's model could be considered more proper model for describing the drying behavior of whole date palm fruits and predicted the change in moisture content during the laboratory drying process.

Table 3: The overall average of the obtained (R^2) and (SE) for both studied drying models.

The model	Coefficient of determination (R^2)	Standard error (SE)
Lewis	0.99191	1.59106
Henderson and Pabis	0.98578	1.96277

To select the best model for describing the drying curves the selected thin layer drying equations were tested. The coefficients of each model were calculated using STATISTICA software. The goodness of fit was evaluated by the coefficient of determination (R^2), mean bias error (MBE), the root-mean-square error ($RMSE$) and the mean square of the deviations between the experimental and calculated values or chi square (x^2) defined by Equations (5) through (7). The best model describing the drying process of whole date palm was chosen as the one with the highest R^2 and the least $RMSE$ and x^2 [15].

$$x^2 = \frac{\sum_{i=1}^N (MR_{calc,i} - MR_{obs,i})^2}{N - n} \tag{5}$$

$$MBE = \frac{1}{N} \sum_{i=1}^N (MR_{calc,i} - MR_{obs,i}) \tag{6}$$

$$RMSE = \left[\frac{1}{N} \sum_{i=1}^N (MR_{calc,i} - MR_{obs,i})^2 \right]^{1/2} \tag{7}$$

Where:

$MR_{obs,i}$ = Observed moisture ratio found in any measurement, decimal

$MR_{calc,i}$ = Calculated moisture ratio for this measurement, decimal.

N and n = Number of observations and constants, respectively. [16,17]

As shown in Table 4, the Lewis's model showed the highest values of coefficient of correlation (r) and lowest values of chi-square (x^2), root mean square error (RMSE). So the Lewis's model was the most appropriate model in describing the drying behavior of whole date palm fruits.

Table 4: The overall average of coefficient of correlation (r), chi-square (x^2), mean bias error (MBE) and root mean square error ($RMSE$) at Lewis’s model and Henderson and Pabis’s models

The model	r	x^2	MBE	$RMSE$
Lewis	0.99595	0.00437	0.03852	0.07064
Henderson and Pabis	0.99285	0.01569	-0.02009	0.07945

CONCLUSIONS

1. The reduction in moisture ratio of fruits were varied with the experimental treatments and it was increased with the increase of radiation intensity, and the drying air temperature. However, it was decreased with the increase of air velocity.
2. The drying constants of the Lewis's model (k_L) and the Henderson and Pabis’s model (k_H) were found to

- be directly proportional to the air temperature and radiation intensity and be inversely proportional to the air velocity.
- Both studied model could describe the drying behavior of whole date palm fruits. However, the Lewis's model considered more proper for describing the drying behavior and predicting the changes in moisture content in terms of precision and application simplicity.
 - The Lewis's model showed the highest values of coefficient of correlation (r) and lowest values of chi-square (χ^2), root mean square error (RMSE). So the Lewis's model was the most appropriate model in describing the drying behavior of whole date palm fruits.

ACKNOWLEDGEMENTS

The authors wish to thank Cairo University for providing the equipment used in this study. The help of the Agricultural engineering Research Institute, Agricultural Research Center, Dokkie, Egypt Giza, Giza.

REFERENCES

- Chao, C.T. and Krueger, R.R.(2007). The date palm (*Phoenix dactylifera* L.): overview of biology, uses, and cultivation. *HortScience*, 42(5), 1077-1082.
- El-Juhany, L.I.(2010). Degradation of date palm trees and date production in Arab countries: causes and potential rehabilitation. *Australian Journal of Basic and Applied Sciences*, 4(8), 3998-4010.
- FAO [Food and Agriculture Organization], Crop production and trade data (2014). Available at: <http://faostat.fao.org/site/291/default.aspx>. (Accessed November 17, 2017).
- Bekheet, S.(2013). Date palm biotechnology in Egypt. *App. Sci. Report*. 3 (3): 144-152.
- Mohammed, N.F.H., Heba, H.N., Aya, S.S. and Dina, S.T.(2017). Effect of Addition Dates "Hayani" on Yield, Chemical Composition and Sensory Evaluation of Ice Cream. *American Journal of Food Science and Nutrition Research*. Vol. 4, No. 5, pp. 170-176.
- Aravindh, M.A. and Sreekumar, A.(2015). Solar Drying A sustainable way of food processing. In *Energy Sustainability Through Green Energy*, Springer India, 27-46.
- Falade, K.O. and Abbo, E.S.(2007). Air-drying and rehydration characteristics of date palm (*Phoenix dactylifera* L.) fruits. *Journal of Food Engineering* 79, 724–730.
- Mongpraneet, S., Abe, T. and Tsurusaki, T.(2002). Accelerated drying of welsh onion by far infrared radiation under vacuum conditions. *Journal of Food Engineering*, 55, 147–156.
- Hebbbar, H.U. and Rostagi, N.K.(2001). Mass transfer during infrared drying of cashew kernel. *Journal of Food Engineering*, 47, 1–5.
- Jones, P.(1992). Electromagnetic wave energy in drying processes. In A. S. Mujumdar, (Ed.), *Drying _92*, (pp. 114–136). Amsterdam: Elsevier Science.
- Sandu, C.(1986). Infrared radiative drying in food engineering: a process analysis. *Biotechnology Progress*, 2, 109–119.
- Jain, D. and Tiwari, G.N. (2003). Thermal aspect of open sun drying of various crops. *Energy*, 28, 37-54.
- A.O.A.C., Official methods of analysis of the association of official analytical chemists, Arlington, Virginia (1990).
- A.O.A.C., Official method of analysis, association of official analytical chemists. Washington, D.C. USA(1995).
- Zakipour, E. and Hamidi, Z.(2011). Vacuum drying characteristics of some vegetables. *Iranian Journal of Chemistry and Chemical Engineering*. 30(4): 97-105.
- Sarsavadia, P.N., Sawhney, R.L., Pangavhane D.R. and Singh, S.P.(1999). Drying behaviour of brined onion slices. *J Food Eng.*; 40:219–226. doi: 10.1016/S0260-8774(99)00058-8.
- Pangavhane, D.R., Sawhney, R.L. and Sarsavadia, M.(2000). Drying kinetics studies on single layer Thompson seedless grape under controlled heated air conditions. *J Food Process Pres.*, 24, 335-352.