

Research Journal of Pharmaceutical, Biological and Chemical Sciences

Particle Swarm Optimization Based Maximum Power Point Tracking Algorithm for Solar System.

P Madhava Sarma^{1*}, S Arulkumar², M Sridevi³, and P Veeraragavn⁴.

¹Saraswathy College of Eng. &Tech, Tindivanam, 604305 India

²Research Scholar, Anna University, Chennai, India

³Agni College of Technology, Chennai, India

⁴University College of engineering, Anna University Chennai, Tindivanam, 604001

ABSTRACT

Recent advancement in the technology has revolutionized the power sector industries in terms of both speed and accuracy. In the power electronics industries major challenge is maintaining the quality of power which is largely dependent on the harmonics reduction for efficient operation of the instruments. In this work, solar power based UPQC is designed, developed and tested for improving the power quality of an electrical power system. In order to increase the efficiency, MPPT controllers are used. Such controllers are becoming an essential element in PV systems. Tracking control strategies PSO have been proposed using MATLAB software in this study to extract maximum power from the PVar ray. The average value of THD for voltage obtained using Particle swam optimization (pso) based controller is 0.98 percent and the average value of THD for current obtained using pso based controller is 1.18 percent.

Keywords: PSO, MPPT, controllers, PV array

**Corresponding author*

INTRODUCTION

The main concern to the power reliability and the power quality become stringent due to the standard application of variable frequency and variable speed drives, robots, accurate digital-control machines, programmable logic controllers, automated production lines information manage systems in Computers and so on. The aforementioned equipment and computer systems are very sensitive to the power supply ripple and various disturbances. All these equipment's are nonlinear loads and become major sources of harmonics. Several power quality problems may result in the decrease of product quality or confusion of management order which means great financial loss.

Unified Power Quality Conditioner (UPQC) has acknowledged exceptional attention during the last two decades due to their most important gain in conserving the quality of power at different load or voltage oscillations. The active power filtering technique has developed as one of the best solutions for mitigation of for most power quality problems.

Vidhya K Viswambaran et al. (2016) have discussed about mathematical modeling and simulation of maximum power point algorithm to investigate the tracking efficiency at different atmospheric conditions 60W PV panel is used here because the panel output current is used for maximum power point tracking. It gives a simulation based comparative study between two popular methods Perturb and Observe (P&O) and Incremental Conductance (In Cond) to optimize the energy conversion efficiency of the PV system. The various MPPT techniques were compared based on certain parameters like convergence speed, complexity, reliability, sensitivity, ability to track true maxima. Mohammad Jafari et al. (2012) have briefly discussed about Full Bridge Series-Parallel DC converter is used to optimize the maximum power point from the PV panel.

Gow et al. (1999) have explained the use of a microcontroller allows for easy updates and enhancement by simply adding code libraries. Furthermore, it can be interfaced via standard communication means to other control devices, integrated into control schemes and remote controlled through its embedded web server. The most common MPPT methods are the open circuit voltage method, the incremental conductance method, the ripple based method, the perturbation and observation (P&O) and proportional integral (PI) methods. The P&O technique is used for pursuing the maximum power point through variation in irradiance and temperature. As its name designate, the P&O method works by perturbing V_{pv} and observing the impact of this change on the output power of the PV array. The closed loop PI controller is also used for MPPT of solar array, which varies the duty cycle of DC-DC converter.

The maximum power point can be found for quantified solar irradiation and temperature condition but they display oscillatory performance around the maximum power point under normal working conditions. Moreover, the system will not respond rapidly to rapid changes in temperature or irradiance. On the other hand, the PI controllers are permanent-gain feedback controllers and they cannot reimburse the parameter variations in the process and cannot adapt changes in the environment. Also, PI controlled system is less responsive to real and relatively fast alterations in state and so the system will be leisurelier to reach the set point. Jiang et al. (2005) clearly explained an intelligent control technique using connected with a MPPT controller is in essential which improves the energy conversion efficiency of the photovoltaic system. Hamid Reza et al. (2014) have explained new approach for modulation of an 11-level cascaded multilevel inverter using selective harmonic elimination (SHE). The dc sources feeding the inverter are considered to be varying in time. In this approach the switching angles are obtained offline for different dc source values. Then an artificial neural network (ANN) is trained to determine the switching angles that correspond to the real-time values of the dc sources in each phase.

Tutkun (2010) has compared the two algorithms for inverter. They have anticipated the hybrid genetic algorithm over Newton-Raphson method to reduction the THD in a single phase PWM inverter Yahia et al. (2010) have designed the algorithm for inverter. Which offered a new improved version of (DEA) Differential Evolution Algorithm. In this algorithm is used to suppress the harmonics in the inverter and find the 17 optimum switching angles of a Programmed Pulse Width Modulation (PPWM) controlled inverter. Ssamudin Ali Ebrahim et al. (2015) have clearly determined compensation technique for separately excited DC motor .The instantaneous reactive power compensation of harmonics in the power network for the above motor obtained using artificial bee colony (ABC) optimization. It describes the use of ABC algorithm for designing the self tuning self-adaptive PID controller to adjust dc-link capacitor voltage of shunt active power

filter. Shindo et al. (2011) have explained about switching angle control concepts for that the efficiency of the inverter can be optimized through Particle Swarm Optimization (PSO) methods. Mohammad Mardaneh & Faranak Golestench et al. (2014) has designed method for obtain the values of the switching angles using the new finding technique called optimization algorithm named Enhanced Teaching-Learning Based Optimization (ETLBO) in order to remove harmonics in multilevel inverters (MLIs). IztokFister et al. (2013) have designed the new algorithm using the swarm intelligence technique .It is a very influential optimization method if it is combined with other algorithms. Finally it was concluded in the work is Bat algorithm hybridized with differential evolution strategies is greater to original bat algorithm.

MAXIMUM POWER POINT TRACKING ALGORITHM FOR SOLAR SYSTEM

The solar system connected structure is shown in figure 1in this system solar system output (V_{pv} and I_{pv}) and boost converter output (V_L and I_L) are compared and output error signal is given to the MPPT system using PSO techniques. The MPPT algorithm is used to improve the power stability. The output (voltage and current) is feedback to PSO for MPPT system.

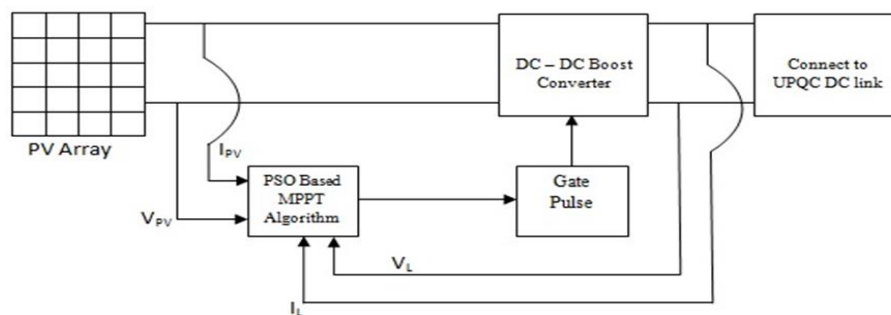

Figure 1: Solar system connect to dc link capacitor terminals of UPQC

The PSO techniques is calibrate the value and given to the pulse generation of switch depending on the duty cycle. The duty cycle is used to finding the value of the switching pattern (ON and OFF period) for the DC-DC boost converter switch. The output of DC-DC is connected to the DC link capacitor terminals. For multi variable function optimization, the PSO method is the best control because it optimizes to the multi variable function in to single one. The variables are randomly initialized for the given space and decide the number of variables are determines the dimension of space. Every particle need to record its own objective function value. For updating the velocity (P_i) and position (P_g) in the optimization technique from the following equation.

$$V_{ik+1} = wv_{ik} + c_1r_1 (p_{ik} - x_{ik}) + c_2r_2 (p_{gk} - x_{ik}) \tag{1}$$

$$X_{ik+1} = x_{ik} + v_{ik+1} \tag{2}$$

where,

V_{ik+1} is the particle velocity

X_{ik+1} is the present position of the particle

p_{ik} is the P_{best}

p_{gk} is the G_{best}

c_1 and c_2 are random numbers

r_1 and r_2 are learning factors

Algorithm for PSO Implementation:

- Step 1: Limit setting for position and velocity.
- Step 2: Position and velocity values initialization.
- Step 3: Fitness value decision for each particle.
- Step 4: Selection of best fitness.
- Step 5: Status of G-best position.
- Step 6: Repeat Step 3 & 4 till the optimum solution is reached.

Step 7: G-best at the end of the last iteration gives the optimized value.

Step 8: Compute the Duty-cycle.

$$V = 1/(1+v(R_{in}/R_{out})) \tag{3}$$

RESULT AND DISCUSSIONS

The output response with genetic algorithm based PI controllers reveals initial overshoot and the amplitude of current harmonics are more when the load is inconsistent. In order to avoid these disadvantages, better controller options are deliberated. Genetic based intelligent controllers are more operative for complex, nonlinear and ill-defined systems. The intelligent controllers have been developed to improve the system performance by reducing the magnitudes of THD values and the designed controller’s demonstrations reduced initial overshoots.

Genetic algorithm based PI controller is designed for the controlling the voltage and current level in the UPQC system. After obtaining the proper tuning value the genetic algorithm based PI controller output response is shown in Figures from 2to figure 3.The source side voltage waveform from in this work the input voltage is $V_{rms}=1.1\cdot 10^4$ for all the phases and the current I_{rms} is for phase-A 594.2 A, phase-B 620.9 A and phase-C 592.9 A. The real and reactive power is shown in Figure 2and figure 3 from the Figures the waveform of load side real and reactive power is improved $P_{load}=1.95\cdot 10^5$ and $Q_{load}=0.38\cdot 10^5$ from source side real and reactive power $P_{source}=17.3\cdot 10^4$ and $Q_{source}=10\cdot 10^4$ respectively.

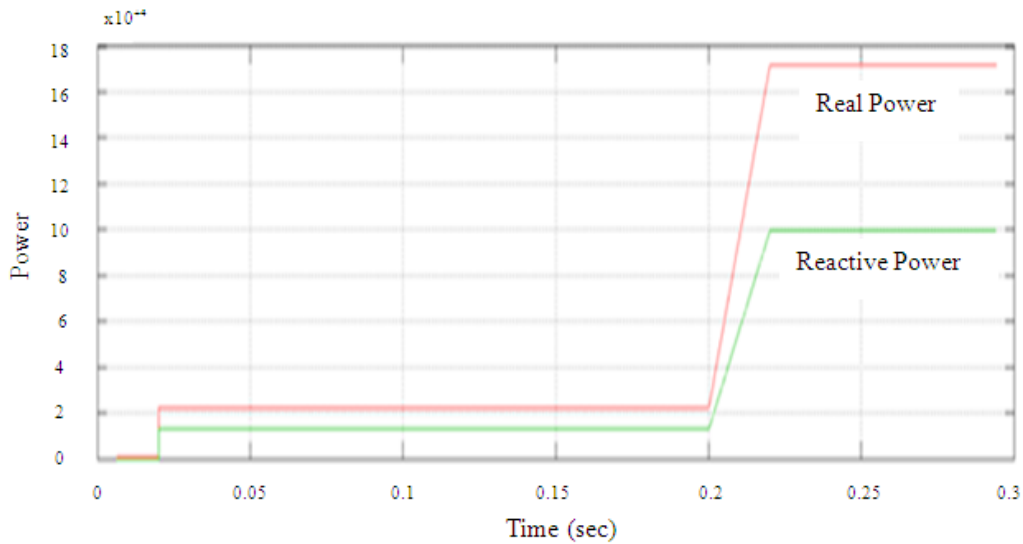

Figure 2: Waveform of Real and Reactive power for source side

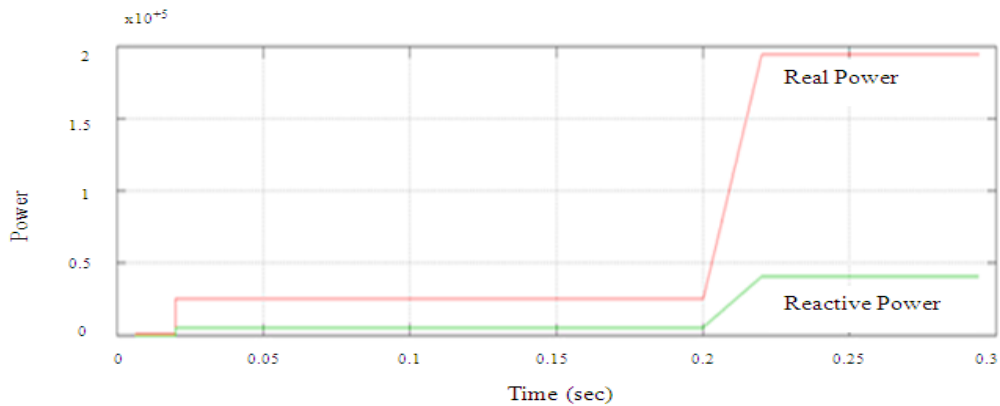

Figure 3: Waveform of Real and Reactive power for load side

Output response with Genetic Algorithm for THD level

Genetic algorithm based Controller output response and FFT window for THD for UPQC system. The Figure clearly indicates that the THD values for various phase voltage such as phase A, phase B and Phase C respectively. The Figure 4 shows the voltage harmonics values after compensation for phase A is 0.95% and the Figure 5 shows phase B value is 1.04% and Figure 6 shows phase C value 0.96%. The Figure 7 shows the current harmonics values after compensation for phase A is 1.15% and the Figure 8 shows phase B value is 1.47% and Figure 9 shows phase C value 0.94%.

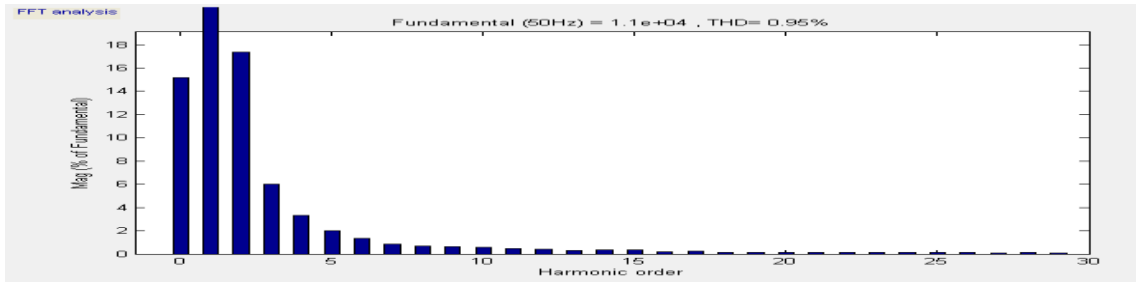

Figure 4: THD level of voltage harmonics for phase A

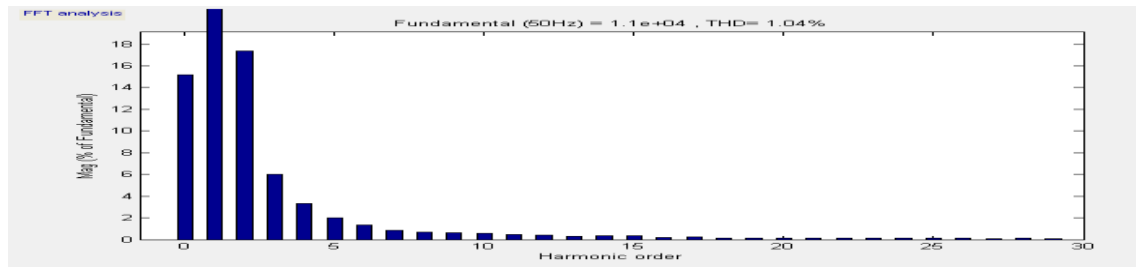

Figure 5: THD level of voltage harmonics for phase B

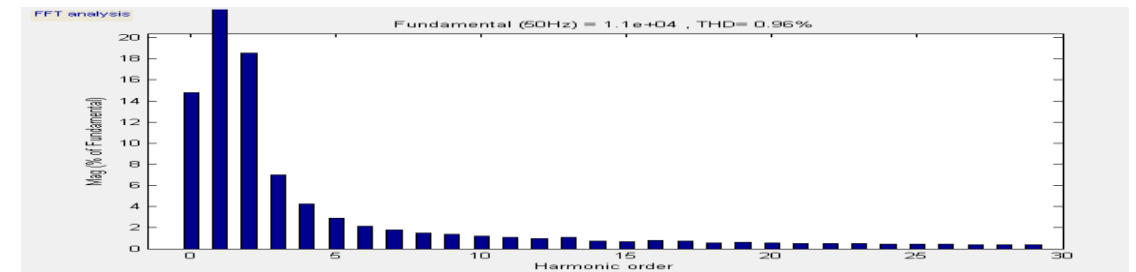

Figure 6: THD level of voltage harmonics for phase C

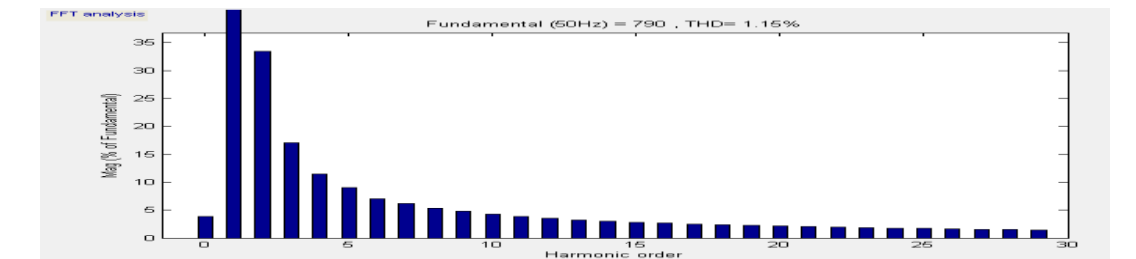

Figure 7: THD level of current harmonics for phase A

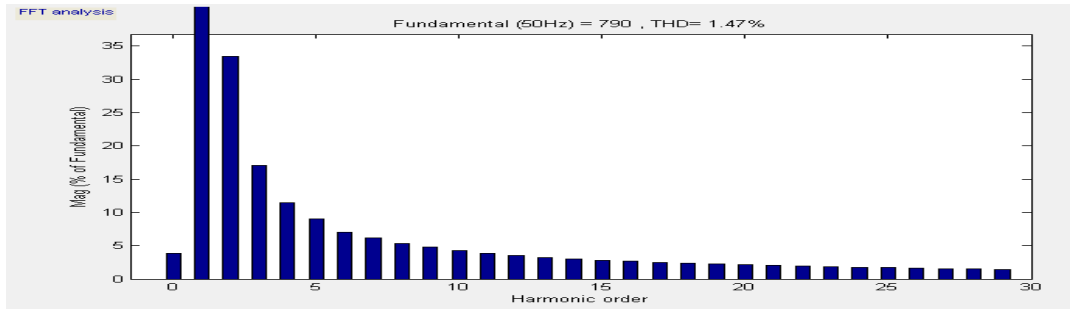

Figure 8: THD level of current harmonics for phase B

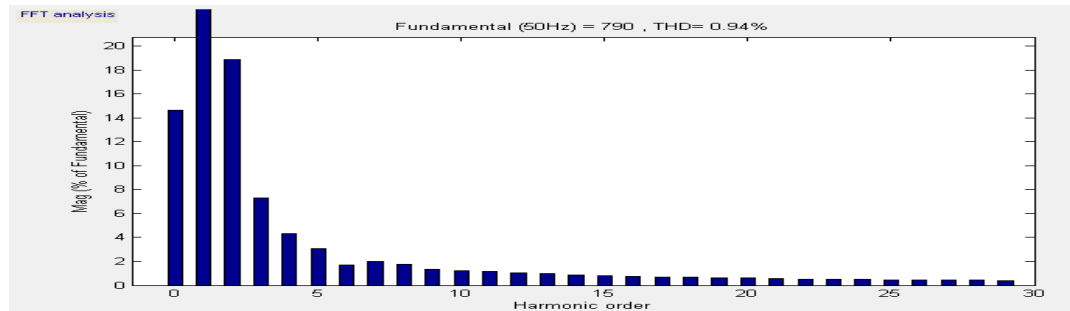

Figure 9: THD levels of current harmonics for phase C

Table 1: Comparison of Harmonics result with different controller

S.NO	Controller	THD for Voltage Harmonics (%)			THD for Current Harmonics (%)		
		Phase A	Phase B	Phase C	Phase A	Phase B	Phase C
1	Without controller	13.22	13.71	13.50	15.91	15.02	15.52
2	PI	3.01	2.33	2.98	4.86	4.02	4.56
3	Fuzzy	1.11	1.29	1.07	2.02	2.48	1.56
4	Neural Network	1.02	1.07	1.03	1.50	2.10	1.04
5	Genetic Algorithm	0.95	1.04	0.96	1.15	1.47	0.94

CONCLUSION

Particle Swarm Optimization based algorithm to minimize the THD value when applied to UPQC. The objective was also to compare the results obtained from PSO algorithm with Genetic Algorithm. The lesser THD results shows that PSO algorithm can be implemented in UPQC system. From Table.1 it is inferred that Genetic Algorithm based controller gives better result.

REFERENCES

- [1] Vidhya, K, Viswambaran, ArfanGhani&Erping Zhou 2016, 'Modelling and Simulation of Maximum Power point Tracking Algorithms & Review of MPPT Techniques for PV Applications', 5th International Conference on Electronic Devices, Systems and Applications (ICEDSA).
- [2] Mohammad Jafari, Zahra Malekjamshidi&JianGuo Zhu 2012, 'Design, Simulation and Implementation of an Intelligent MPPT using a ZVCS Resonant DC-DC Converter', IEEE International Conference on Power and Energy (PECon).
- [3] 3.19. Gow, JA & Manning, CD, March 1999, 'Development of a photovoltaic array model for use in power electronics simulation studies', IEE Proceedings on Electric Power Applications, vol. 146, no. 2, pp. 193-200

- [4] Hamid reza Mohammadi & Ali akhavan 2014, 'A new adaptive SHE method for cascaded multilevel inverters using evolutionary methods', IEEE 23rd International symposium on industrial electronics, pp.1484-1489.
- [5] Tutkun, N 2010, 'Improved Power Quality in a Single Phase PWM Inverter Voltage with Bipolar Notches through the hybrid genetic Algorithms', International Journal on Expert Systems with Applications, vol. 37, no. 8, pp. 5611-562.
- [6] Yahia, H, Liouane, N & Dhifaoui, R 2010, 'Weighted Differential Evolution Based PWM Optimization for Single Phase Voltage Source Inverter', International Review of Electrical Engineering, vol. 5, no. 5, pp. 1956-1962.
- [7] Essamudin Ali Ebrahim 2015, 'Power-Quality Enhancer using an Artificial Bee Colony-Based Optimal-Controlled Shunt Active Power Filter', WSEAS Transactions on Systems, vol. 14, pp. 90-10.
- [8] Shindo, T, Kurihara, T, Taguchi, H & Jinno, K 2011, 'Particle Swarm Optimization for Single Phase PWM Inverters', IEEE Congress on Evolutionary Computation, New Orleans, vol. 5-8, pp. 2501-2505.
- [9] Mohammad mardaneh & Faranak Golestench 2014, 'Harmonic Optimization of Diode-Clamped Multilevel Inverter using Teaching learning based optimization Algorithm', IETE Journal of research, vol. 59, no. 1, pp. 9-16.
- [10] Iztok Fister, Dusan Fister & Xin-She Yang 2013, 'A Hybrid Bat Algorithm', Elektrotehniski Vestnik, Original Scientific Paper, vol. 80, no. 1-2, pp. 1-7.
- [11] P. Madhavasarma and S. Sundaram, "Model based tuning of controller for non-linear hemispherical tank processes," Instrumentation Science and Technology, vol. 35, no. 6, pp. 681-689, 2007.
- [12] P. Madhavasarma and S. Sundaram, "Model based evaluation of controller using flow sensor for conductivity process," Sensors & Transducers Journal, vol. 79, pp. 1164-1172, 2007